

ATK SPACE SYSTEMS, INC.
LOS ANGELES, CALIFORNIA

PROPELLANT TANK ASSY

CAGE CODE	SIZE	ENG NO.	REV.
18229	E	80511	B
SCALE: 1/2		SHEET 1 OF 3	

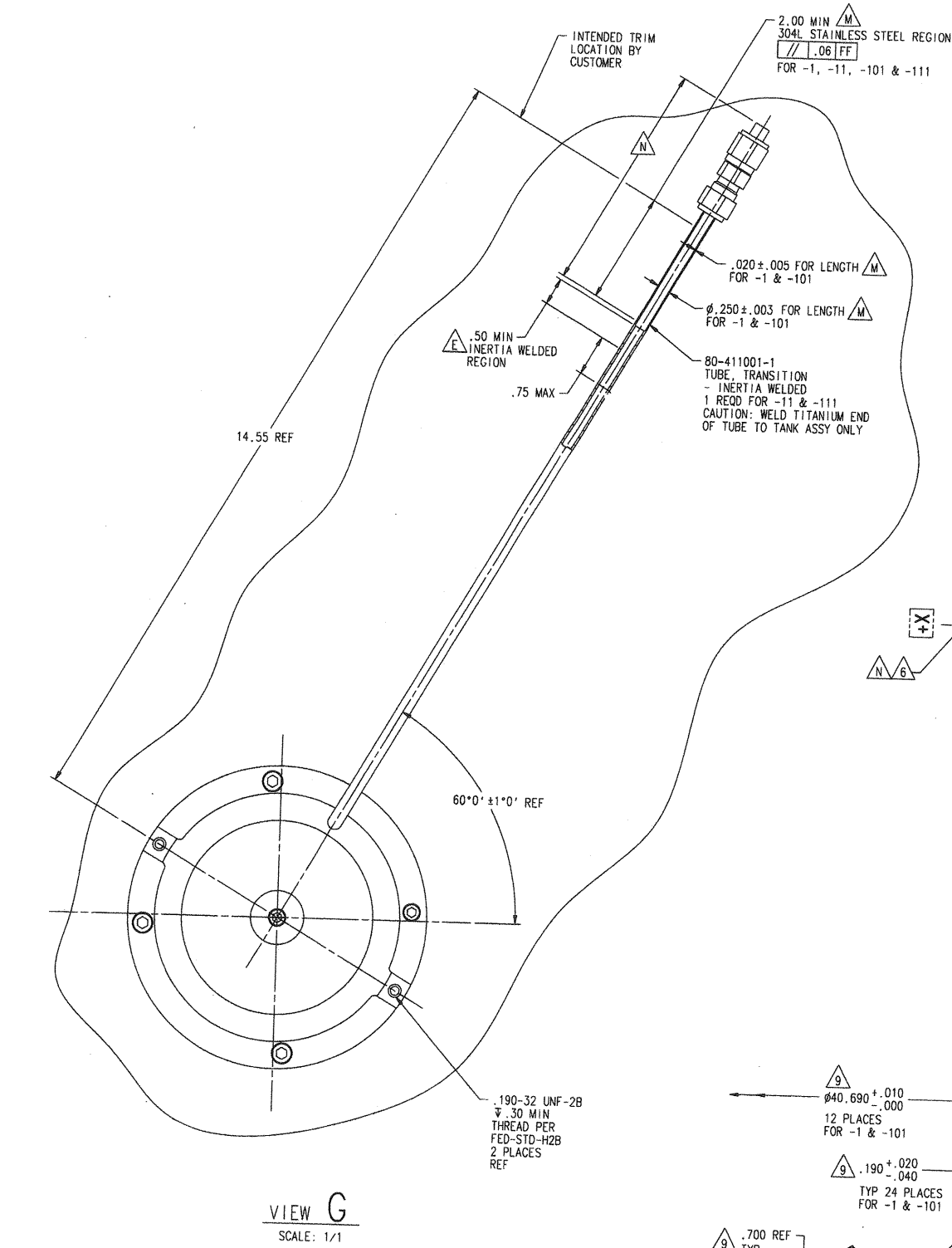

VIEW G
SCALE: 1/1

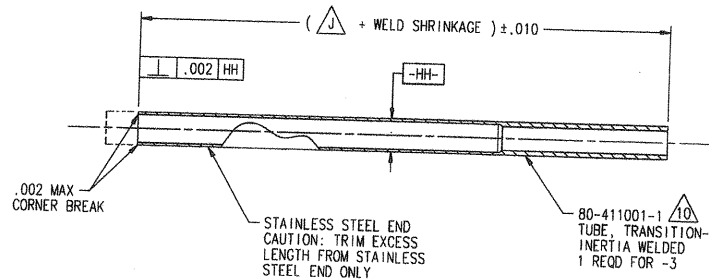

DETAIL -3
SCALE: 2/1

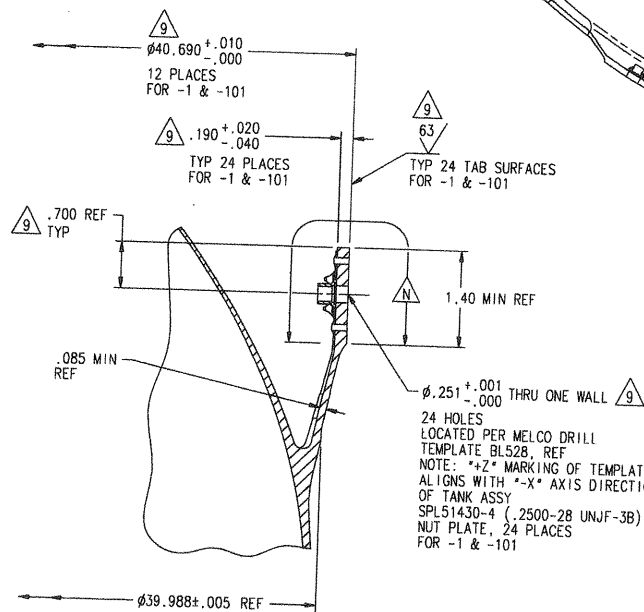

SECTION J-J
SCALE: 1/1
BACKGROUND GEOMETRY OMITTED FOR CLARITY

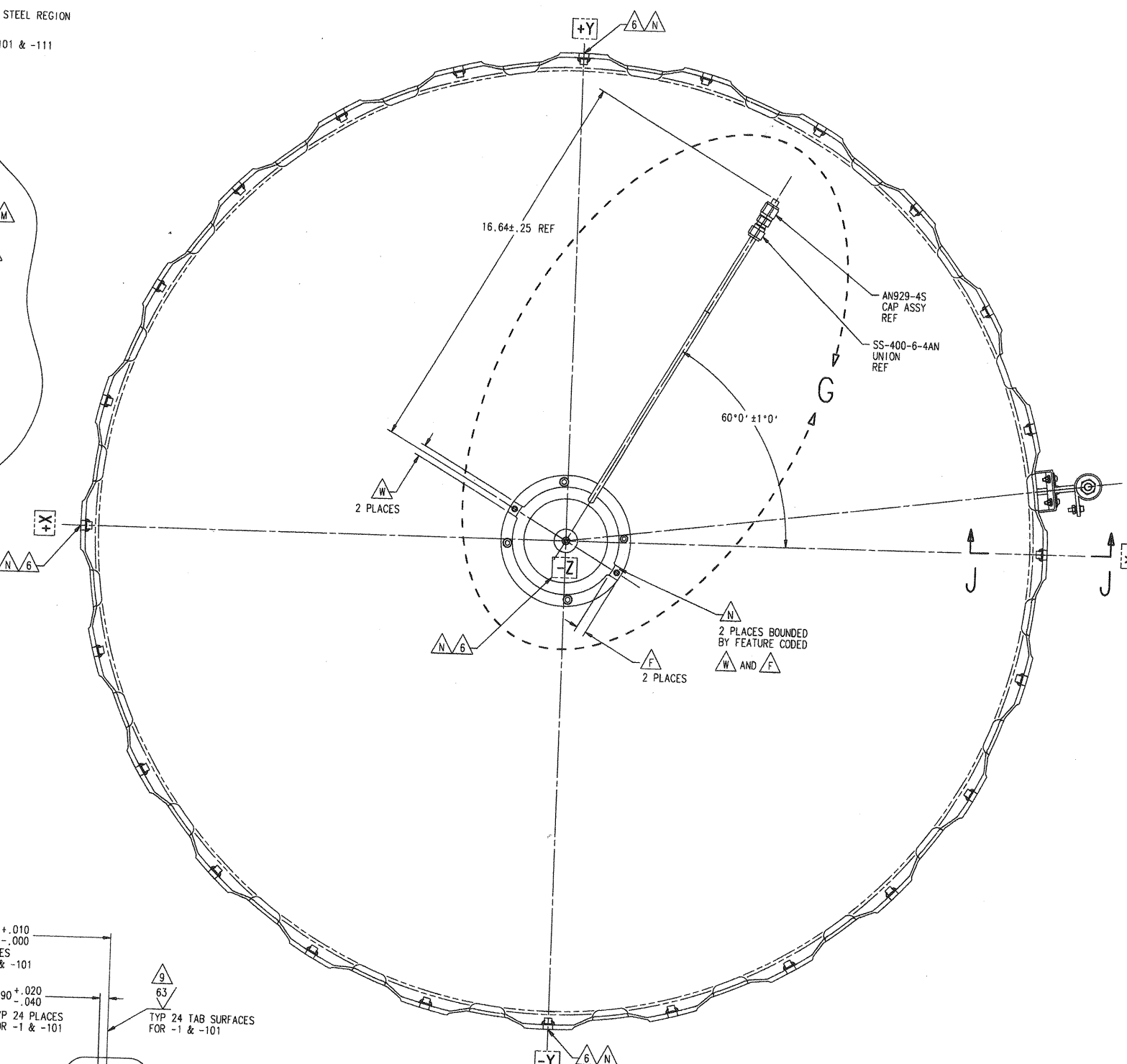

VIEW A-A SHEET 1

ATK SPACE SYSTEMS, INC. LOS ANGELES, CALIFORNIA			
PROPELLANT TANK ASSY			
CAGE CODE 18229	SIZE E	DWG NO. 80511	REV. A
SCALE: 1/2	SHEET		2 OF 3

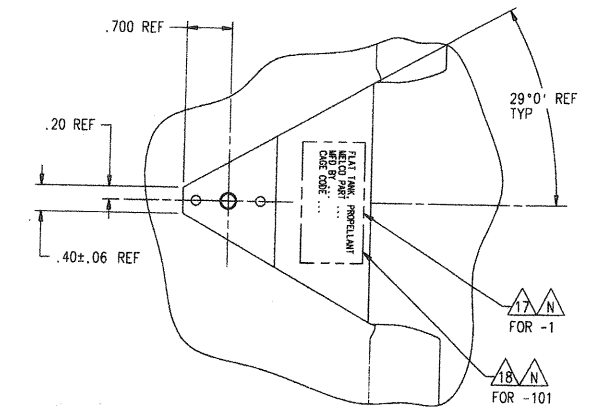
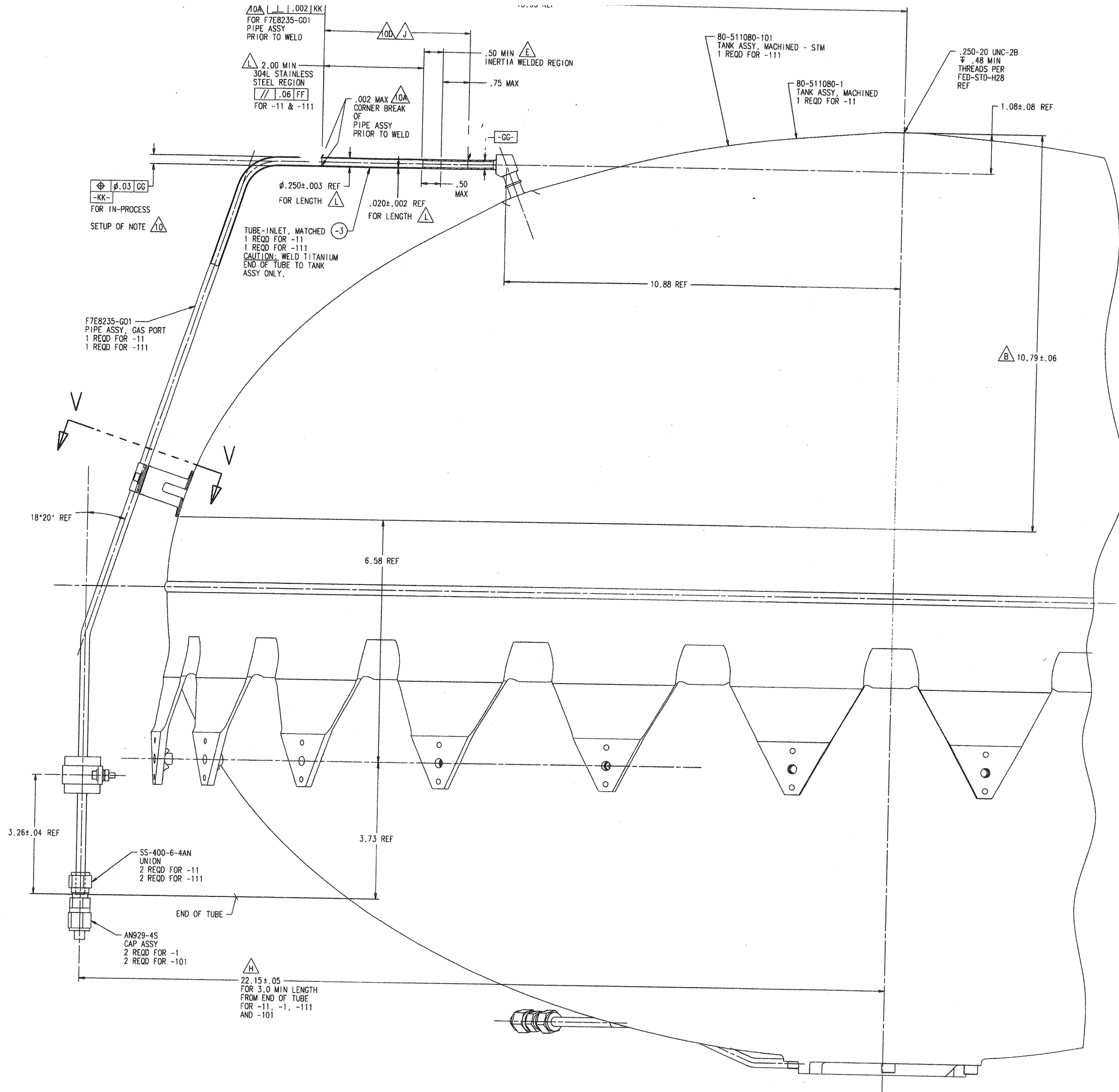

VIEW U SHEET 1

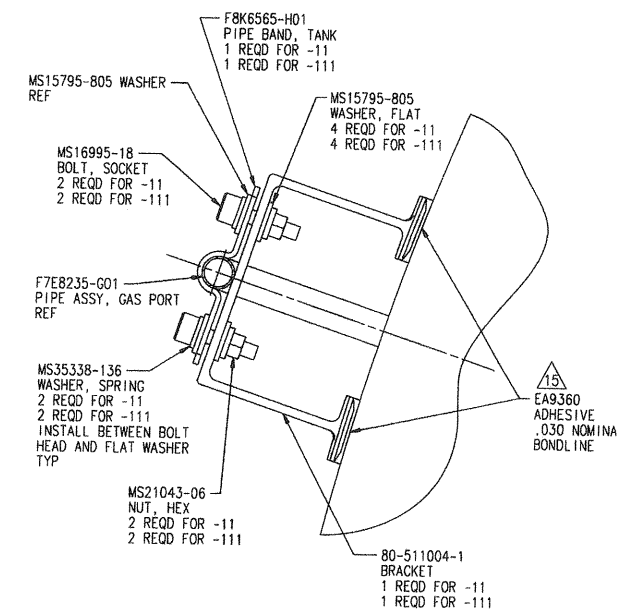

VIEW V-V
 PARTIAL BACKGROUND OMITTED FOR CLARITY
 SCALE: 2/1

ATK SPACE SYSTEMS, INC. LOS ANGELES, CALIFORNIA			
PROPELLANT TANK ASSY			
CASE CODE 18229	SIZE E	DWG. NO. 80511	REV. A